



## Summary of the IEC 61850 GOOSE Message vs. Hardwire Time Stamp Deviation and Performance Test:

### Key Conclusions:

- > Not all GOOSE message publishing devices are the same. The time delay between publishing and receiving is vendor-dependent.
- > There is a large difference in timestamp updates depending on vendor and equipment models.
- > Using merging units and GOOSE messaging, the time delay from contact closure to event receipt at the client is more predictable than direct hardwired contacts to the client.
- > The time delay from GOOSE publisher to client event receipt is a few milliseconds slower than direct hardwired contacts.

## WELCOME TO THE Q3 2015 EDITION OF THE NEXSTATION LAB REPORT

**For the non-technical reader:** The left-hand sidebar provides a summary of our results, while the report below describes the technical details, including test setup, execution and the results.

## GPS Event Time Comparisons to GOOSE and Hardwire Timestamps

### INTRODUCTION

Welcome to the latest edition of the Nexstation Lab Report. This quarter, we continue our investigation of 61850 event time stamping and the variances between different 61850 vendors and hard-wired inputs.

This quarter's test is set up with each of our test devices wired to open and close a single interpose latching relay whose outputs are wired to the input of our test devices and our GPS clock event capture input.

One of the devices per test publishes a GOOSE message containing the same event information to all the devices. We cycled the interpose relay between the CLOSE and OPEN states ten times capturing the hardwired input and subscribed GOOSE message device internal target timestamp along with the GPS event timestamp.

Three difference tests were performed using a different vendor to publish the GOOSE message in each of the tests. See **Figure 1** (above) to view the test configuration.

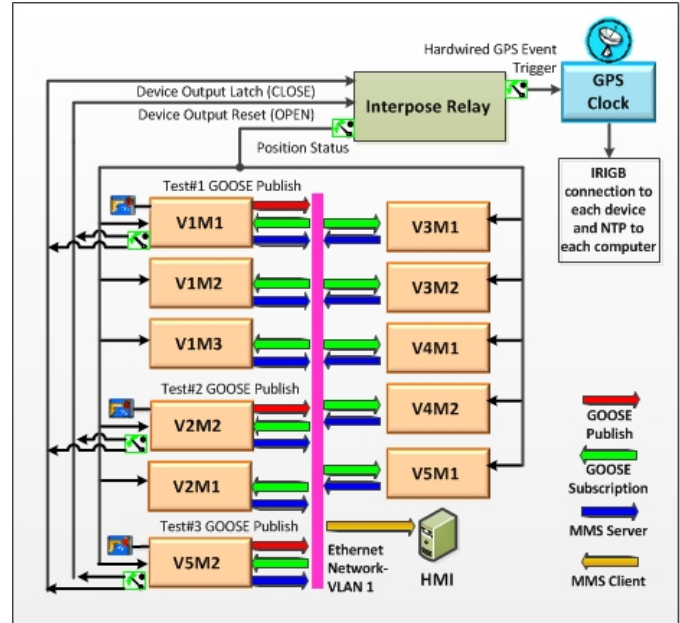

Figure 1: Test Configuration

### GOALS

- Compare both hardwired and GOOSE event capture time stamps with the GPS clock event capture.
- Use three different vendor devices for the GOOSE publishing to compare vendor performance.
- Determine device event notification time deviation between the two methods.

### EXECUTION

Using a programmed button on the GOOSE publishing device, we cycled OPEN – CLOSE events on the interpose relay. For each of the events we recorded the hardwired status input time stamp for the position change. For the subscribing devices, we recorded the publishing device's hardwired input change of state timestamp as reported by the subscribed GOOSE message. We also recorded the event timestamp as recorded by the

### SOLICITING YOUR INPUT:

We value your feedback and welcome input. Send your testing ideas to: [solson@powereng.com](mailto:solson@powereng.com)

### Disclaimer

This report is meant for informational purposes only. POWER Engineers, Inc. cannot be held responsible for readers' interpretation or use of this information. No endorsement of products or vendors is intended or implied. Trademarks and brands noted herein are the property of their respective owners.

To receive a PDF copy of this newsletter quarterly, please send an email to [solson@powereng.com](mailto:solson@powereng.com) or call 406-237-2000 and ask for Scott Olson.

GPS clock. There was a total of three tests conducted, each using a different GOOSE publish device..

### TEST RESULTS

For all the test results we averaged the 20 data samples, 10 OPEN and 10 CLOSE events, and used this information for our analysis.

#### Test #1

For the first test, we used V1M1 as the GOOSE publishing device. **Figure 2** (below) shows the average GOOSE event receive and hardwired input event timestamp comparisons to the GPS event timestamp.

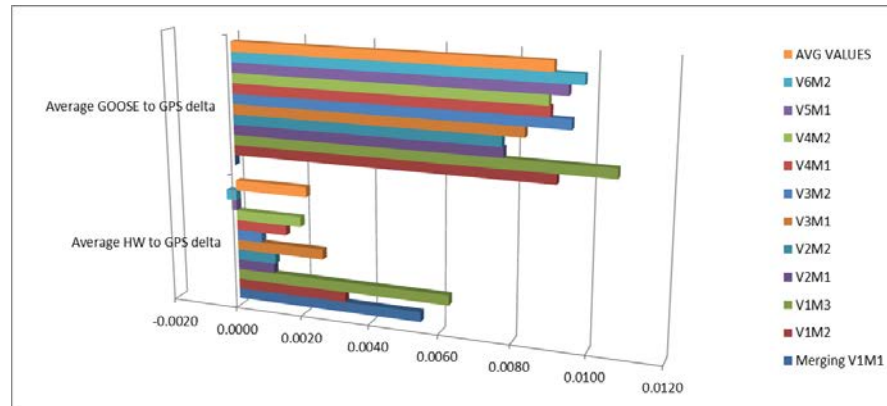

Figure 2: Test 1 Timestamp Comparisons

Looking at the GOOSE timestamp delta, we see that all the devices were very close in their results with an average delta of ~9 ms.

The hardware timestamp deltas vary a lot more between the various

vendors and models with an average delta of ~2 ms.

**Figure 3** (below) looks at the average of all the sample averages and devices. Using V1M1 as the GOOSE publisher, the mean delta GOOSE timestamp difference from the GPS clock is 9.6 ms with a standard deviation of 1.08 ms. The hardwired input timestamp delta to the GPS clock shows a mean of 1.2 ms with a standard deviation of 2.15 ms. This shows us just how much difference exists among the various vendors and models.

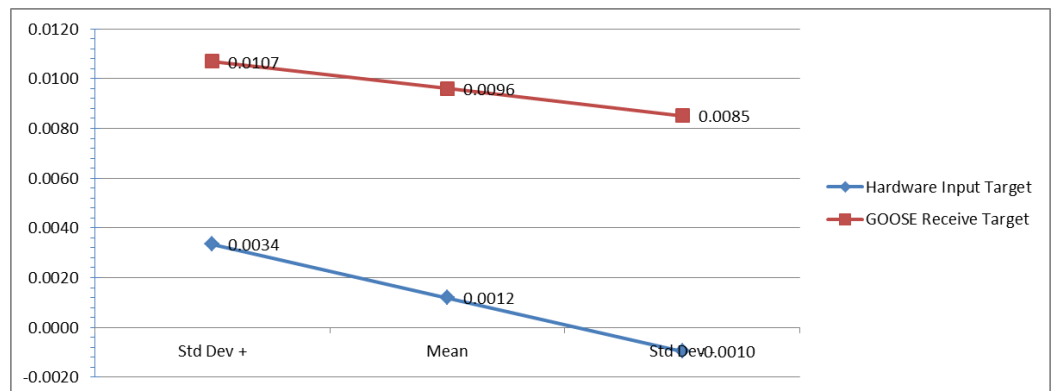

Figure 3: Test 1 Timestamp Averages

## Test #2

For the second test, we used V2M2 as the GOOSE publishing device. **Figure 4** shows the average GOOSE event receive and hardwired input event timestamp comparisons to the GPS event timestamp.

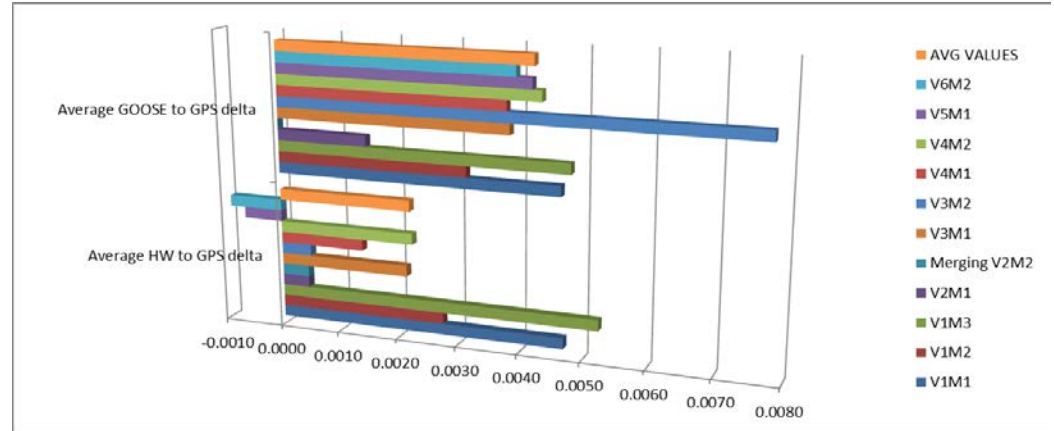

Figure 4: Test 2 Timestamp Comparisons

Looking at the GOOSE timestamp delta, we see that all the devices were much closer in their results than in Test 1, with the exception of one device.

The average delta of just over 4 ms is also significantly better than the results of test #1. The hardware timestamp deltas still show a lot of variance between the various vendors and models with an average delta of ~2 ms.

**Figure 5** (below) shows the average of all the sample averages and devices. Using V2M2 as the GOOSE publisher. The mean delta GOOSE timestamp difference from the GPS clock is 3.3 ms with a standard deviation of 1.69 ms. The hardwired input timestamp delta to the GPS clock shows a mean of 0.5ms with a standard deviation of 2.03ms. These results are much better than the first test.

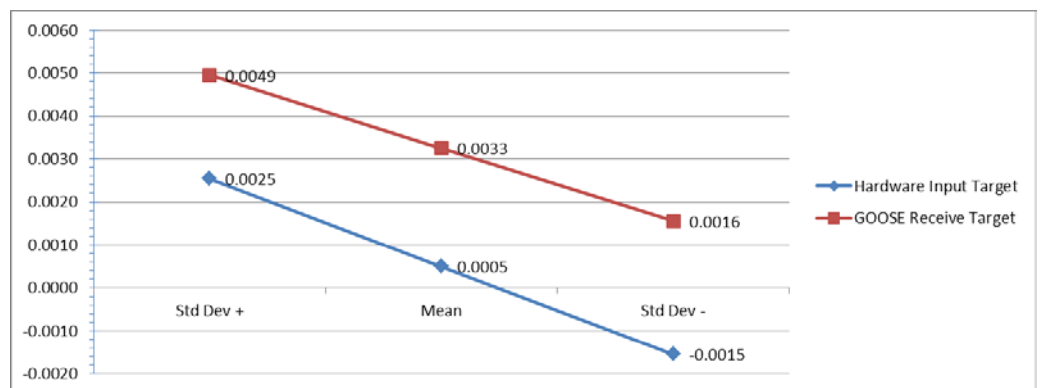

Figure 5: Test 2 Timestamp Averages

### Test #3:

For the third test, we used V2M2 as the GOOSE publishing device. The first thing to note for Test #3 is that the data is missing for V2M1. We could not get this device to properly subscribe to the GOOSE message published by V5M2.

**Figure 6** (below) shows the average GOOSE event receive and hardwired input event timestamp comparisons to the GPS event timestamp. Looking at the GOOSE timestamp delta, we see similar results shown in Test 1, with all the devices being relatively close. The average GOOSE delta was just over 8 ms. The hardware timestamp deltas still show a lot of variance between the various vendors and models with an average delta of ~2.5 ms.

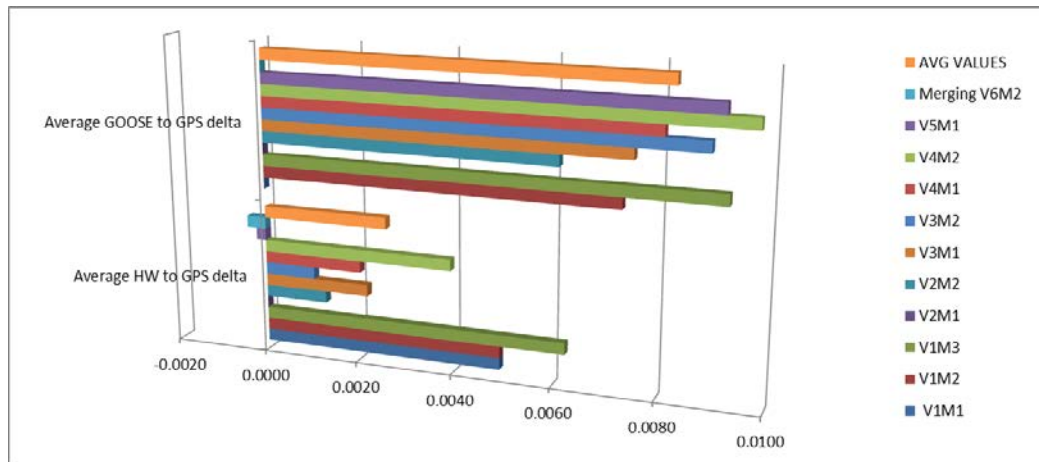

Figure 6: Test 3 Timestamp Comparisons

**Figure 7** (below) looks at the average of all the sample averages and devices. With using V5M2 as the GOOSE publisher the mean delta GOOSE timestamp difference from the GPS clock is 8.4 ms with a standard deviation of 1.23 ms. The hardwired input timestamp delta to the GPS clock shows a mean of 0.5 ms, with a standard deviation of 2.32 ms.

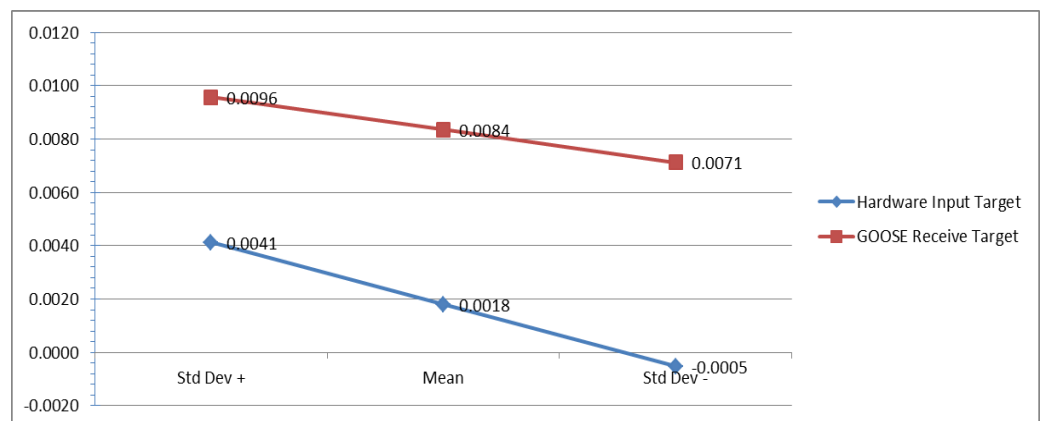

Figure 7: Test 3 Timestamp Averages

## SUMMARY

---

The results of these tests show a real picture of the time differences we would expect from deploying merging units that first capture the hardwire event and then publish it out onto the Ethernet network using GOOSE vs. wiring that same contact directly to all the devices.

Our previous test reports have shown that the GOOSE message transport time from device to device is between 3 and 4 ms. Looking at the GOOSE event receive timestamp delta from GPS event timestamp, the average mean delta for all devices over the three tests is 7.07 ms, with a standard deviation of 1.34 ms.

The first question that comes to mind is: Why is the difference greater than the transport times?

The answer is in the deviation of the devices clock and the GPS clock. We are counting on the device's IRIGB connection to keep the internal clock very close to the GPS time. But looking at the hardwired timestamp deltas, we know this is not the case. The Hardwired Input Event Receive Timestamp delta from GPS Event Timestamp Average mean delta for all devices over the three tests was 1.34ms, but the standard deviation was 2.17ms. There is a big difference in how the various vendors and model update their clocks and timestamp.

We have also seen a difference in GOOSE timestamps depending on which device was publishing. This test shows the importance of properly selecting the right equipment for either conventional implementations or IEC 61850.